

# Planche marquages Z30AE

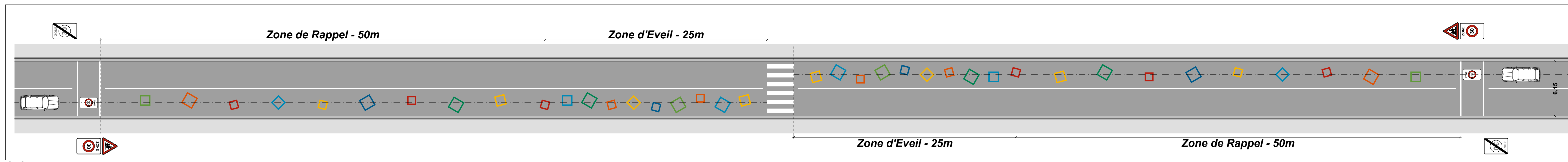

CAS 1 - 2x1 bande avec marquage axial

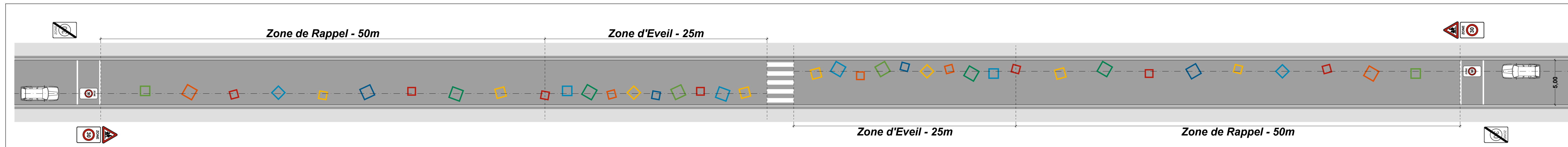

CAS 2 - 2x1 bande sans marquage axial

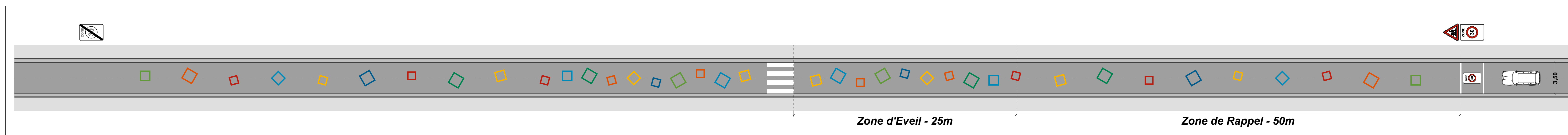

CAS 3 - 1 bande

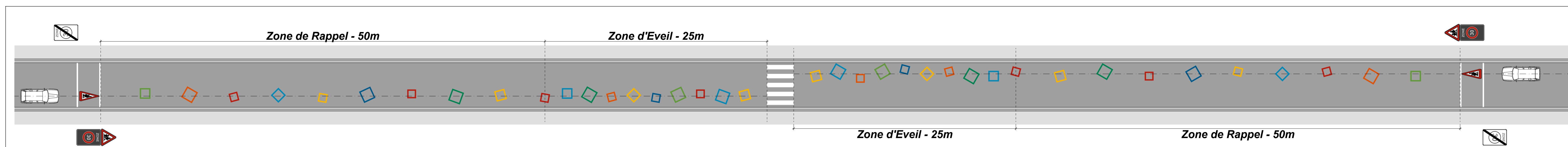

CAS 4 - Z30AE variable (PMV)

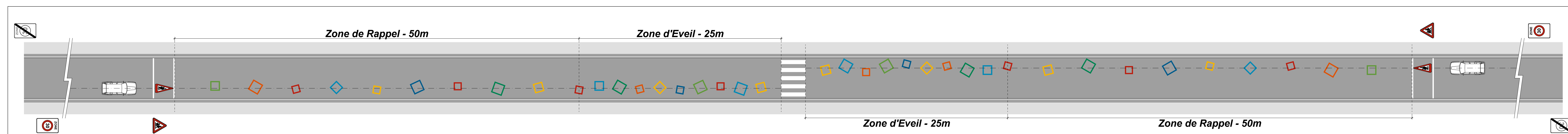

CAS 5 - Zone 30 classique comprenant un endroit spécialement fréquenté par des enfants

## Zones d'entrée

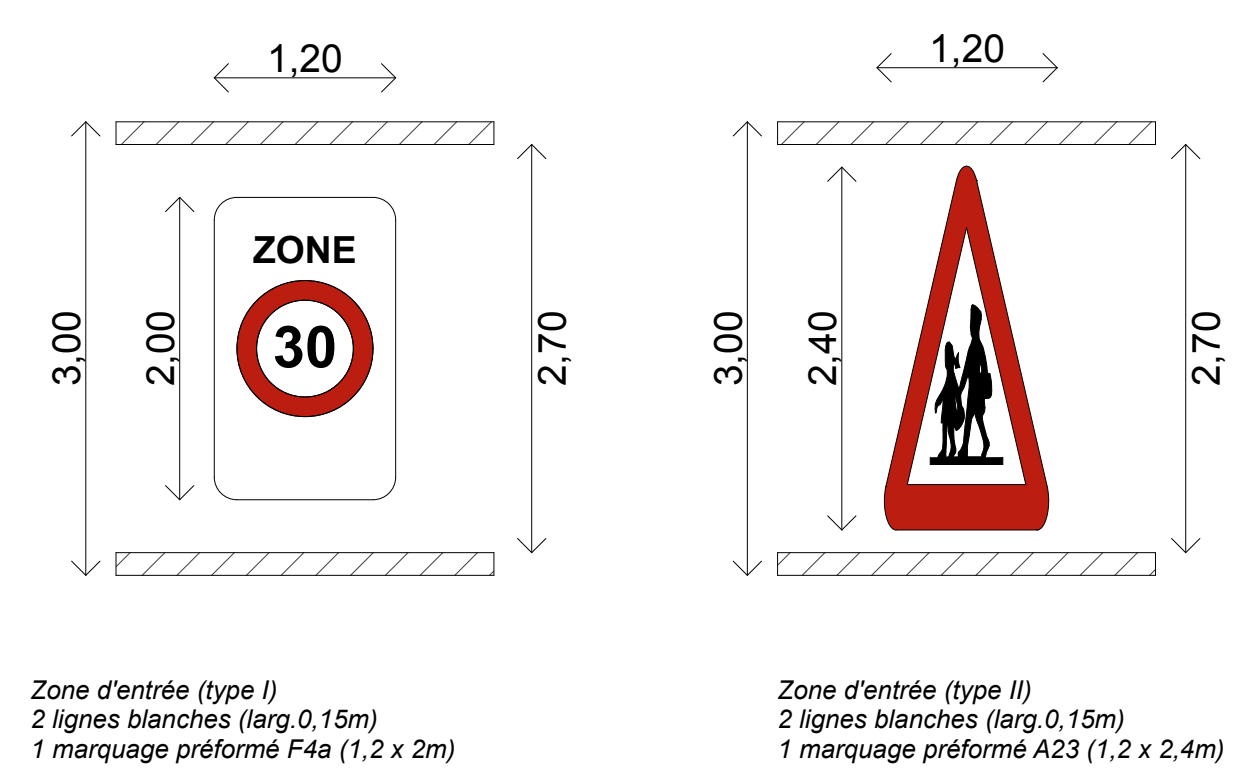

## Zone d'éveil et zone de rappel - Formats marquages

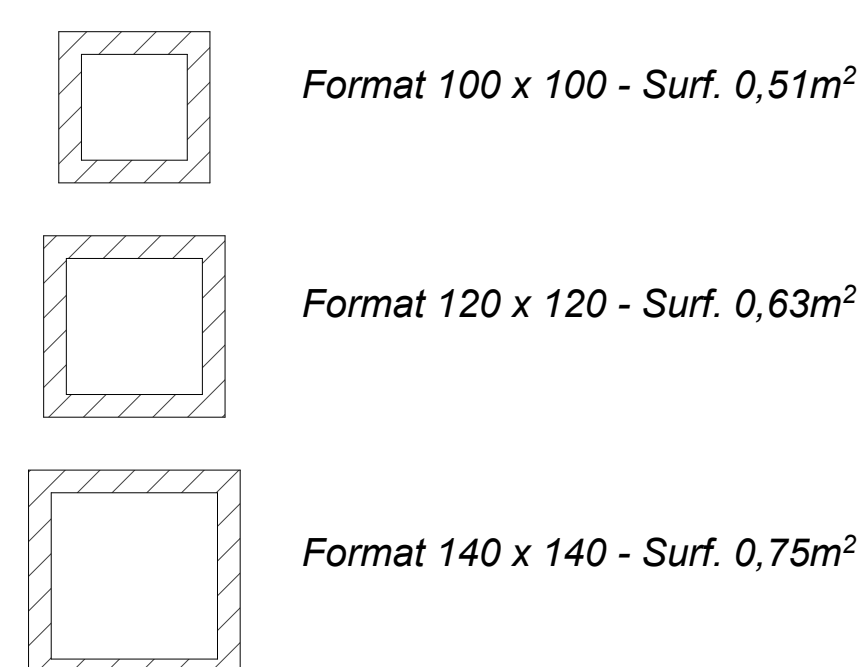

## Marquages - Palette couleurs

